

UCCELLO  
KETTLE

USER GUIDE &  
WARRANTY INFORMATION





Please ensure that a minimum of 0.7 litres (3 cups) of water is in your Uccello Kettle before every boil. Failure to do so, will substantially reduce the life of your Uccello Kettle and will adversely affect your guarantee.

Product Model/Code: UDK\_BW  
Manual v.3.0





# PAGE CONTENTS

Important Safety Instructions	5
Know Your Kettle	9
Operation	13
Care & Cleaning	14
Warranty & Registration	15
Warranty Terms & Conditions	16
Troubleshooting Guide	17
Thank You	18
Warranty Form	19

[www.uccellodesigns.ie](http://www.uccellodesigns.ie)



[customercare@uccellodesigns.com](mailto:customercare@uccellodesigns.com)

# IMPORTANT SAFETY INSTRUCTIONS







When using electrical appliances, basic safety precautions should always be followed, including the following:

-  **Please read all of this instruction manual before using your Uccello Kettle.**  
Store/save this manual in a safe place for future reference.

## Before Use

-  Before connecting the Uccello Kettle to the power supply, check that the voltage indicated on the appliance corresponds with the voltage in your home. If this is not the case, do not use the Kettle and contact us via email on [customercare@uccelodesigns.com](mailto:customercare@uccelodesigns.com).
-  Check that the cord supplied is free from defects. If the cord is damaged do not use the Kettle and contact us via email on [customercare@uccelodesigns.com](mailto:customercare@uccelodesigns.com).

## During/After Operation

-  Always fill the Uccello Kettle above the minimum (0.7L / 24fl. oz / 3 cups) and to below the maximum of (1.5L / 50fl.oz / 6 cups) as indicated on the kettle.
-  Should you accidentally operate the Uccello Kettle with less than the minimum amount of water it will result in irreparable damage to the kettle.
-  To avoid the risk of damaging the heater element inside the Uccello Kettle, do not operate the Kettle without water inside.
-  Should you accidentally operate the Uccello Kettle without water, the Boil-dry protection will automatically switch the Kettle off. If this should occur, allow the Kettle to completely cool before filling with cold water and re-boiling. Repeated use without water will result in irreparable damage to the kettle.
-  Do not fill the Uccello Kettle beyond its maximum safe fill level of 1.5L / 50fl.oz / 6 cups (labeled MAX on the Water Level Indicator).
-  If the Uccello Kettle is overfilled, boiling water may overflow down the internal steam tube, into the electrics and it will result in irreparable damage to the kettle.
-  Boiling an overfilled kettle runs the risk of boiling water being ejected.





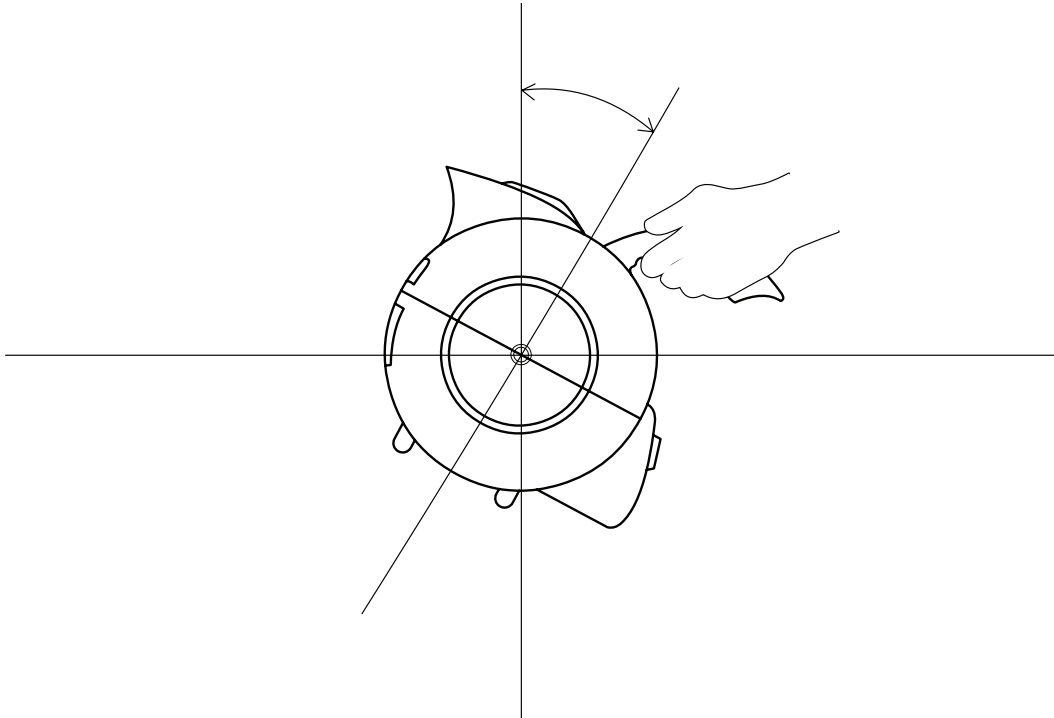

# IMPORTANT SAFETY INSTRUCTIONS

- ⚠ Do not to tip the Uccello Kettle backwards as illustrated by the diagram below; doing so will cause water to pour from the back of the kettle and will damage it. This action is a misuse of your kettle.



- ⚠ The Uccello Kettle should be used for boiling water only. Do not boil any other liquid or substance in the kettle.
- ⚠ Only operate the Uccello Kettle on a flat and stable surface, out of reach of children.
- ⚠ Extreme caution must be taken when handling the Uccello Kettle containing hot water.

# IMPORTANT SAFETY INSTRUCTIONS

-  Be cautious of steam exiting the spout whilst boiling water and whilst opening the lid after the boiling cycle. Contact with steam can cause scalding. To avoid scalding, always ensure the lid is closed whilst the kettle is boiling.
-  Always take care when pouring boiling water. Make sure to pour slowly and carefully, ensuring not to tip the Uccello Kettle too fast.
-  Take care when opening the lid whilst the Kettle is hot.
-  Do not touch the Uccello Kettle whilst hot, except for the handle and the open lid button.
-  The Uccello Kettle is not a toy.
-  This appliance is not intended for use by persons (including children) with reduced physical, sensory or mental capabilities or lack of experience and knowledge unless they have been given initial supervision or instruction concerning the use of the appliance by a person responsible for their safety. Children should be supervised to ensure that they do not play with the appliance.



# IMPORTANT SAFETY INSTRUCTIONS

## General Safety Information



Only use the Cradle with the Uccello Kettle.



Only use the Uccello Kettle with the Cradle.



Unplug the Uccello Kettle from the power outlet when not in use and before cleaning. When cleaning, ensure the Uccello Kettle is completely cool.



Do not let the cord come into contact with hot surfaces. Do not place any or all parts of the Uccello Kettle on or near a hot gas plate or electric burner, or in a heated oven.



Do not let the power cord hang over the edge of tables, counters etc.



To avoid fire, electric shock or personal injury, do not immerse the cord, plug or Uccello Kettle in water or other liquids.



The use of attachments that are not recommended by Uccello Designs may result in fire, electric shock or personal injury.



The Uccello Kettle is intended to be used in household applications for domestic use. Do not use the Uccello Kettle outdoors.



The Uccello Kettle should be kept out of direct sunlight during use and storage.

When using electrical appliances, basic safety precautions should always be followed, including the following:

1. Close supervision is necessary when any appliance is used by or near children.
2. Do not operate any appliance with a damaged cord or plug or after the appliance malfunctions, or has been damaged in any manner. Please contact us via email on [customercare@uccelodesigns.com](mailto:customercare@uccelodesigns.com).
3. To disconnect, turn any control to "off" then remove plug from wall outlet.

**Save these instructions.**



# KNOW YOUR KETTLE

## Main Parts

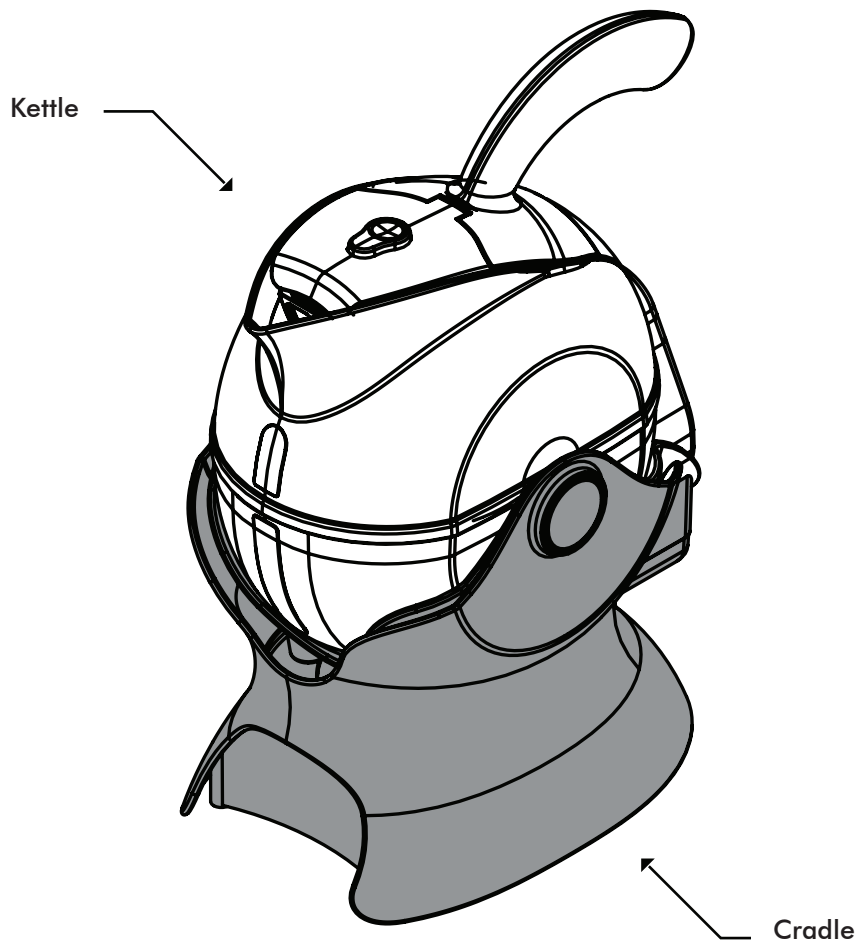

# KNOW YOUR KETTLE

## Kettle Parts

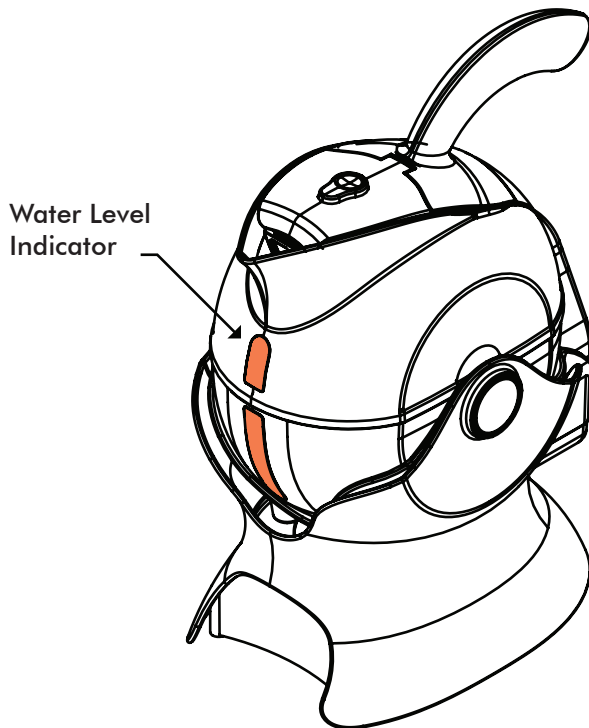
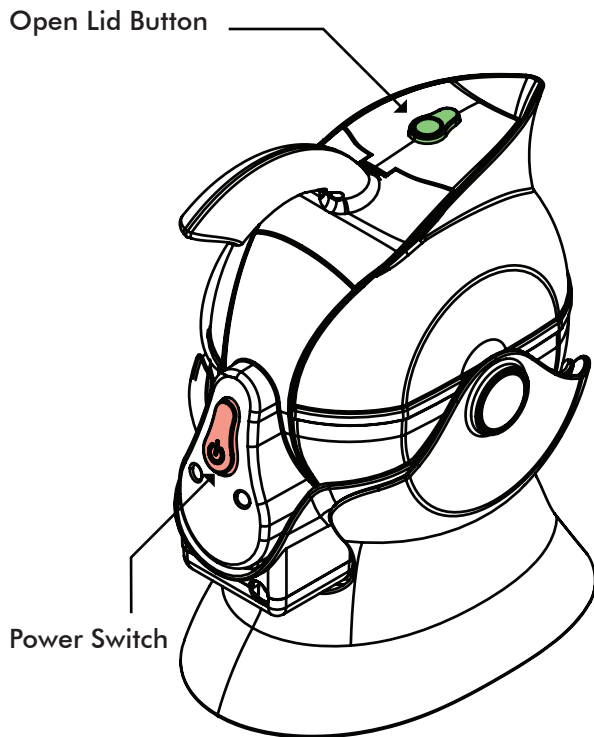

# KNOW YOUR KETTLE

## Detaching from the Cradle

The Uccello Kettle can be lifted out of the Cradle and used independently for pouring and filling. The Kettle can only be boiled whilst sitting in the Cradle.

- a) A short power-supply cord is provided to reduce risks resulting from becoming entangled in or tripping over a longer cord.
- b) Extension cords may be used if care is exercised in their use.
- c) If an extension cord is used:
  - 1) The marked electrical rating of the extension cord should be at least as great as the electrical rating of the appliance;
  - 2) If the appliance is of the grounded type, the extension cord should be a grounding type 3-wire cord; and
  - 3) The longer cord should be arranged so that it will not drape over the counter top or table top where it can be pulled on by children or tripped over.

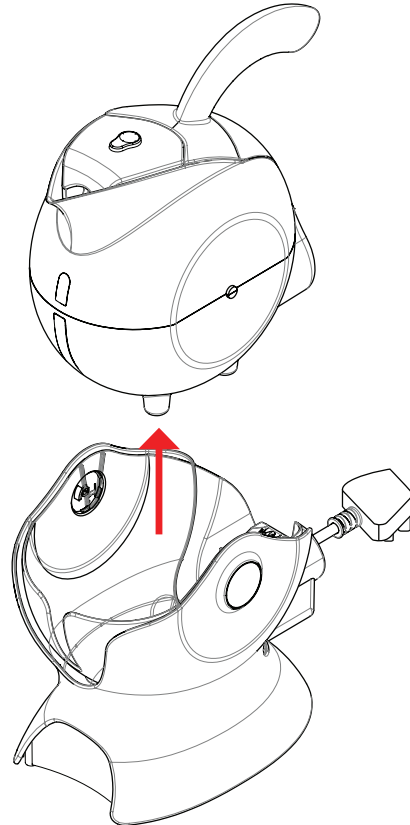

# KNOW YOUR KETTLE

## Unit Rotation

The Uccello Kettle, whilst in the Cradle, can rotate on a vertical axis up to 80°, allowing you to pour boiled water without the need to lift the Kettle.

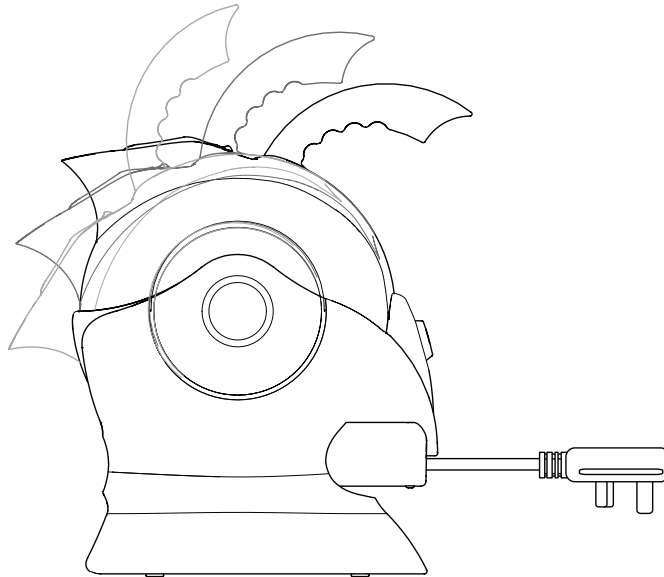

# OPERATION

## Before Initial Use

If you are using your Uccello Kettle for the first time, it is recommended that you clean your Kettle before use by boiling a full Kettle of water twice and then discarding the water.

## Kettle Operation

**NOTE: Do not fill the water over the maximum level as water may spill out of the spout when boiling. Ensure that the lid is firmly in place before connecting the power cord to the outlet.**

1. Position the Uccello Kettle in the Cradle.
2. Connect the plug into a power outlet. Press the switch Button below the handle. The indicating light in the on/off switch will light up. The Kettle will switch off automatically and the light will extinguish in the on/off switch once the water has boiled. You can shut off the power by pressing the switch button at any point during boiling water.

**NOTE: Ensure that switch is clear of obstructions and the lid is firmly closed. The Kettle will not turn off if the switch is constrained or if the lid is left open.**

3. While holding the handle rotate the Uccello Kettle in the Cradle to pour the water.

**NOTE: Operate carefully when pouring the water from your Uccello Kettle as boiling water may result in scalding. Do not open the lid while the water in the Kettle is hot.**

## Boil-Dry Protect

Should you accidentally allow the Uccello Kettle to operate without water, the Boil-dry protection will automatically switch it off. If this should occur, allow the Uccello Kettle to cool for 30 seconds before filling with cold water and re-boiling.

Repeated dry boiling will result in irreparable damage to the kettle.

# CARE & CLEANING

Always disconnect the appliance from the power outlet before cleaning. Never immerse the Uccello Kettle or cord in water or allow moisture to contact these parts.

## Removal of Mineral Deposits

Mineral deposits in tap water may cause the Uccello Kettle interior to discolour. To remove this build-up use Liquid descaler, a simple to use, non-toxic cleaner.

Alternatively:

1. Fill the Uccello Kettle with 3 cups of white vinegar and the remainder with water and allow to stand overnight. **Do not boil.**
2. Empty the solution from the Kettle, any stains remaining inside the spout can be removed by rubbing with a damp cloth.
3. Fill the Kettle with clean water, bring to the boil and discard the water. Repeat. The Uccello Kettle is ready for use.

**NOTE:** The outside of the Kettle can be wiped over with a damp cloth.

**NOTE:** Do not use harsh chemicals when cleaning the kettle.

## Cleaning the Cradle

Wipe the housing with a mild detergent and damp cloth.

## Cleaning the Filter

Remember to clean the filter with a mild detergent and damp cloth at intervals. The filter can be detached for easier cleaning simply by pulling it out. To attach, insert the filter into the support dent.

## Storage

When not in use or storage, the power cord may be wound around the cord storage under the bottom of Kettle.

## Disposal

You can help protect the environment. Please remember to respect the local regulations: Hand in the non-working electrical appliance to an appropriate waste disposal centre.



# WARRANTY & REGISTRATION

Thank you for purchasing a product from Uccello Designs. We trust it will provide you with many years of reliable service.

We have spent many, many hours carefully designing, and sourcing the best raw materials and components for our products, so they can be built to the highest standard possible.

You are entitled to have the product repaired or replaced if it fails to be of acceptable quality, even if the failure does not amount to a major failure.

To ensure prompt processing of any warranty claims, please complete the product registration online at [www.uccelodesigns.ie](http://www.uccelodesigns.ie) or alternatively complete the form on page 19 and return to Uccello to activate the warranty.

**After registration is complete, you will receive a 10% discount code for your next purchase or gift it to a friend.**

See page 16 for the conditions of the warranty.

Register online at [www.uccelodesigns.ie](http://www.uccelodesigns.ie)

# WARRANTY TERMS & CONDITIONS

## 1. **Warranty**

Uccello Marketing, and its authorised agents, are the sole importers of Uccello branded products, and warrant to the original purchaser that all Uccello products purchased from an authorised stockist will be free from defects in materials and / or workmanship for the duration of the warranty from the date of purchase. Any product deemed faulty in terms of materials and/or workmanship that is returned to Uccello Marketing or the original place of purchase within the warranty period - 24 months from date of purchase, together with proof of purchase, will be replaced free of charge by Uccello Marketing or its authorised agents.

## 2. **Exclusions**

The warranty referred to above does not apply:

- I. To any defect of failure attributable to accident, misuse, abuse, negligence, including non-adherence to the prescribed operation instructions on the part of the user, or to
- II. Improper installation or connection to an inadequate or faulty power source;
- III. If the product has been serviced or repaired by any party not expressly authorized by Uccello Marketing to do so;
- IV. If any serial number has been removed or defaced;
- V. If the product is used outside the country of purchase;

## 3. **Statutory Rights**

The terms of the warranty set out herein are additional to, and in no way limit, vary or exclude any rights conferred by any conditions or warranties imposed by the provisions of the Competition & Consumer Protection Act 2014 Ireland and/or any applicable local legislation in the country of purchase.

This does not affect your statutory rights.

If you have any issues with your Uccello Kettle, please connect with us at:

[customercare@uccelodesigns.com](mailto:customercare@uccelodesigns.com)



# TROUBLESHOOTING GUIDE

No.	Issue	Possible Cause	Possible Solution
1	Kettle won't turn on	Kettle not energised	Check power supply to ensure that it corresponds to the model of the Uccello Kettle purchased - if not please contact us on <a href="mailto:customer care@uccellogdesigns.com">customer care@uccellogdesigns.com</a>
2	Kettle won't turn on	Kettle not energised	Check power cord for defects. If a defect is found please contact us on <a href="mailto:customer care@uccellogdesigns.com">customer care@uccellogdesigns.com</a>
3	Kettle won't turn on	Kettle not energised	Ensure that the Uccello Kettle is placed correctly into the base as identified in this instruction manual
4	Kettle won't turn on	Kettle not energised	Ensure your Bs 1362 compliant 10amp fuse is working (UK and Ireland only)
5	Kettle won't turn on	Insufficient water; dry-boil activated	Pour water into the Uccello Kettle, ensuring that the water level is over the minimum required amount (0.7 litre)
6	On/off switch turns off immediately	Dry-boil activated as kettle has been boiled without the required amount water	Pour water into the Uccello Kettle, ensuring that the water level is over the minimum required amount (0.7 litre)
7	Water leaking from Kettle	Kettle tilted backwards beyond recommended angle	Empty water from kettle and dry comprehensively. Read "safety instructions" section in manual to identify correct use of the Uccello Kettle
8	Water leaking from Kettle	Kettle has been overfilled and boiled	Empty water from kettle and dry comprehensively. Refill the Uccello Kettle to above the minimum (0.7L / 24fl. oz / 3 cups) and to below the maximum of (1.5L / 50fl.oz / 6 cups) as indicated on the kettle.

If you are still unsure of the source of the issue, please contact Uccello Designs via email on [customer care@uccellogdesigns.com](mailto:customer care@uccellogdesigns.com)



# THANK YOU FOR PURCHASING A PRODUCT FROM UCCELLO DESIGNS

We trust it will provide you with many years of reliable service.

If experiencing any difficulties with the product, please see the warranty section within this instruction manual for further information.

To register your Uccello Kettle, visit our website at [www.uccellodesigns.ie](http://www.uccellodesigns.ie)

# WARRANTY FORM

NAME: .....

TOWN/SUBURB: .....

COUNTY/STATE: .....

EMAIL: .....

DATE OF PURCHASE: .....

PLACE OF PURCHASE: .....

BATCH NO.(On the bottom of the product UM###UK2): .....

To assist us in bringing you the product and features that you want and deserve, we would also be grateful if you could complete the following short questionnaire:

WHAT WERE THE TWO MOST IMPORTANT FACTORS INFLUENCING THE CHOICE OF THIS PRODUCT?

Cost     Lack of alternatives     Look of the kettle     The kettle was recommended

DO YOU HAVE ANY SUGGESTIONS TO IMPROVE OUR PRODUCT?

.....  
.....  
.....

TO MAKE YOUR LIFE EASIER WITH LIFTING, MOVING, POURING OR HOLDING; WHERE SHOULD WE SPEND OUR TIME DEVELOPING AIDS TO HELP YOU?

.....  
.....  
.....



AFFIX  
STAMP  
HERE

Delivery Address:

## Uccello Designs

Midlands Innovation & Research Centre,  
AIT, Athlone  
Westmeath  
N37 F6D7  
Ireland